

brilliance in solar lighting

photinus

INSTALLATIONSANLEITUNG INSTALLATION INSTRUCTION V.1 | 2022

protos 125 / 250

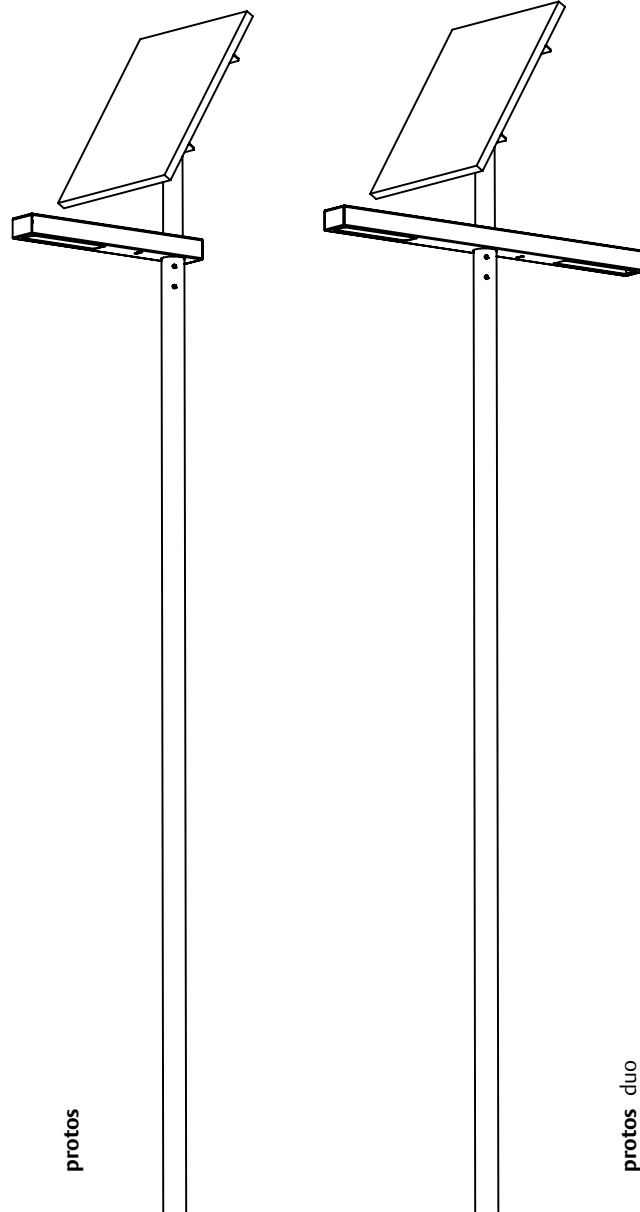

LIEFERUMFANG / INCLUDED PARTS

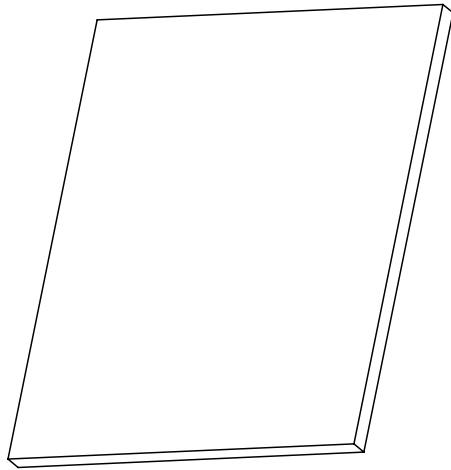

1x

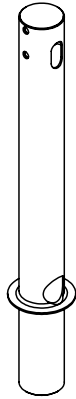

1x



1x



2x



1x



1x

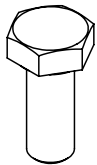

A-8x

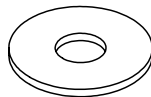

B-4x

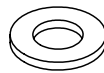

C-12x



D-8x

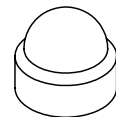

E-8x

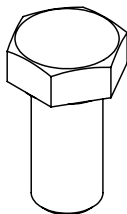

F-4x



K-4x

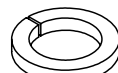

G-4x

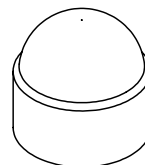

H-4x



J-6x

BENÖTIGTES WERKZEUG IHRERSEITS / TOOLS REQUIRED

1 Inbusschlüssel / Allen Wrench 4 / 5 / 6 mm
 1 Gabelschlüssel / Open Wrench - SW 13

1 Torx 20 Schraubendreher / torx 20 screwdriver
 1 Ratschensatz / Nut runner - SW13 / SW 19

PHOTOVOLTAIK MODUL / PHOTOVOLTAIC MODULE

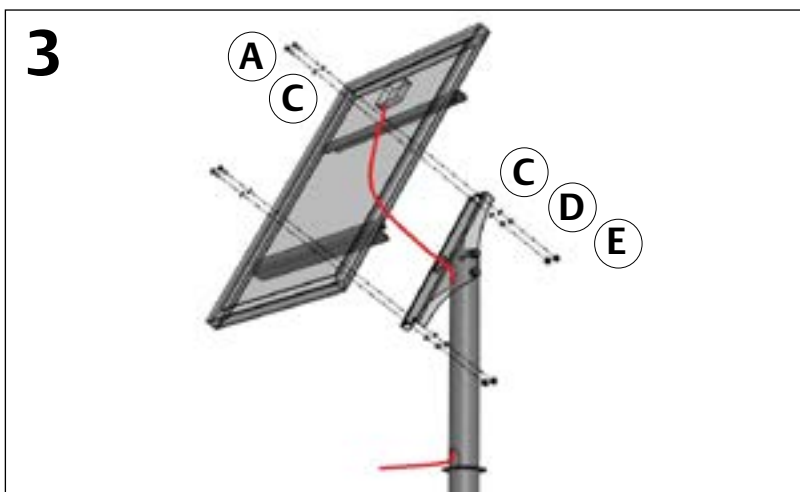
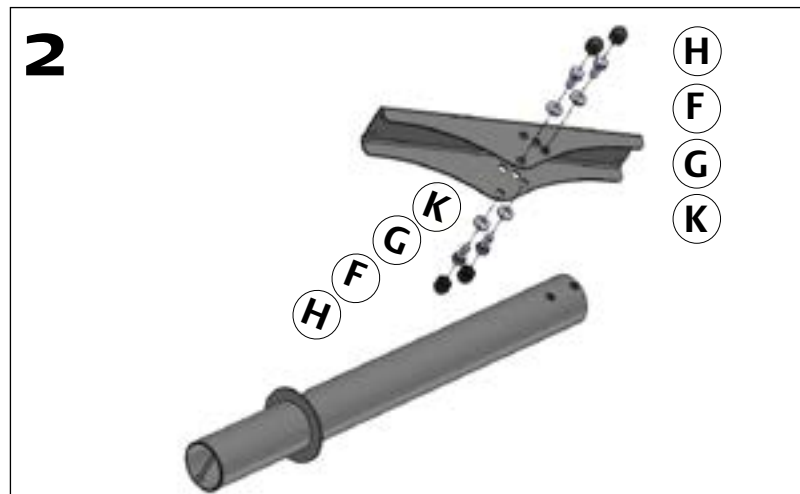
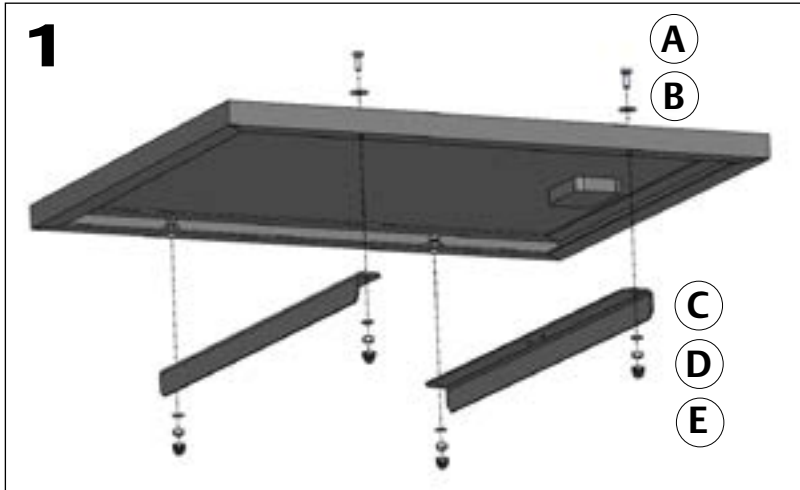

LICHTGEHÄUSE / LIGHT HOUSING

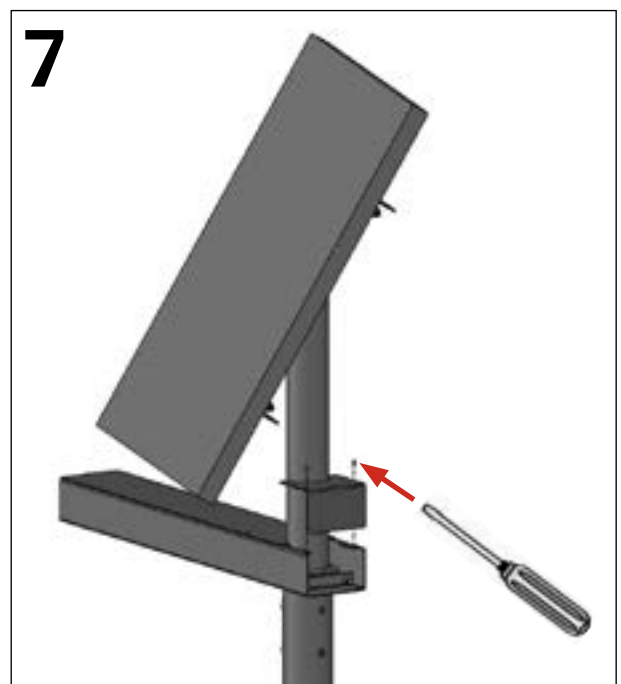
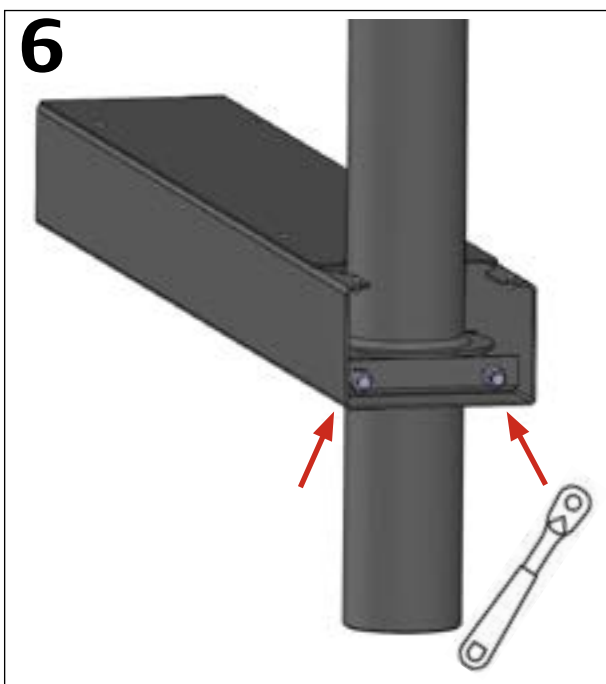
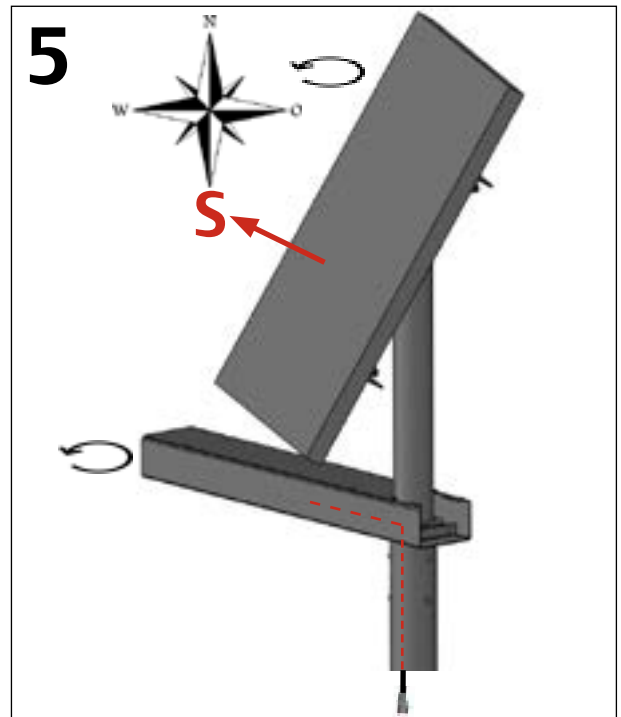

AKKU UND LICHTMAST / BATTERY AND POLE

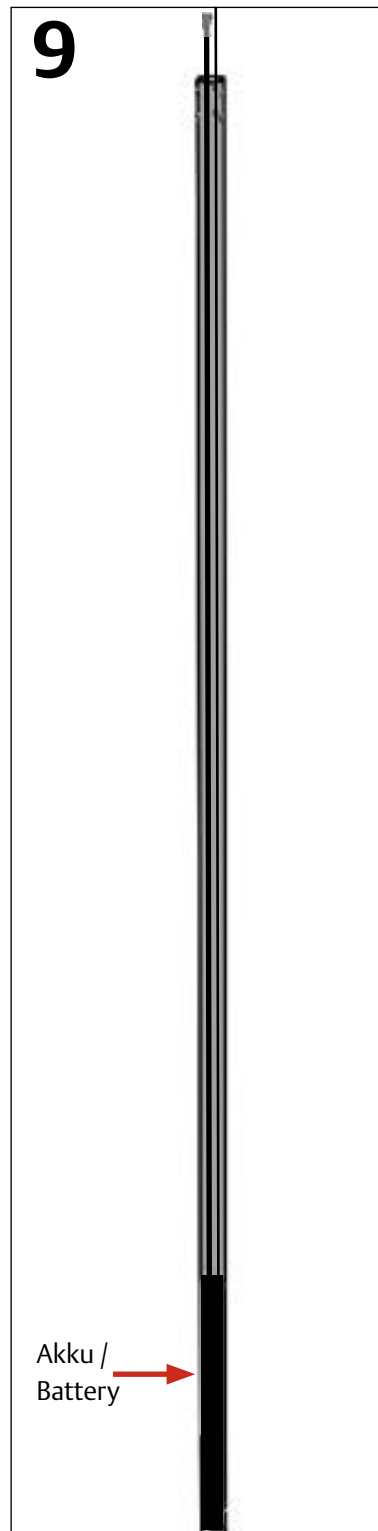
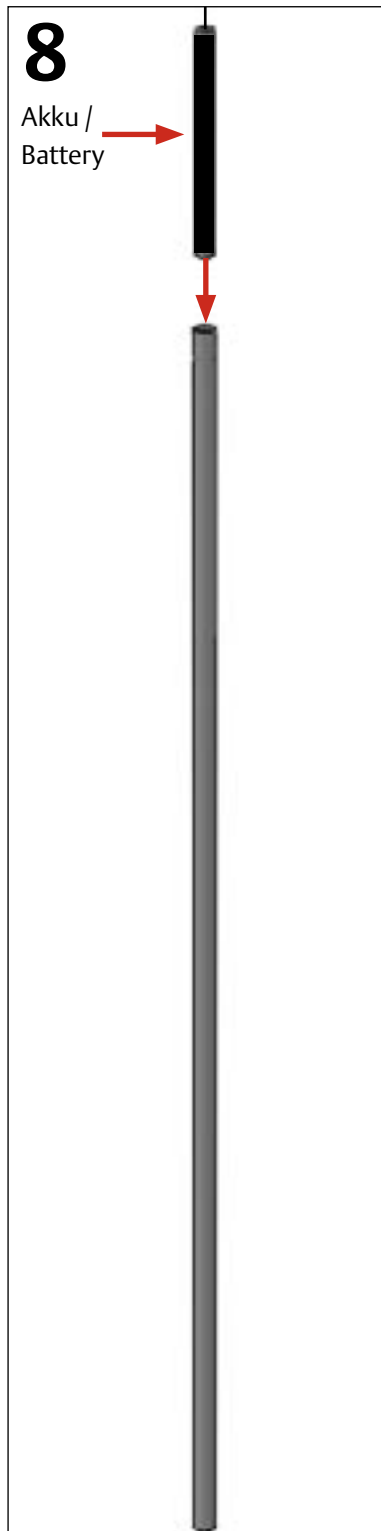

AKKU UND LICHTMAST / BATTERY AND POLE

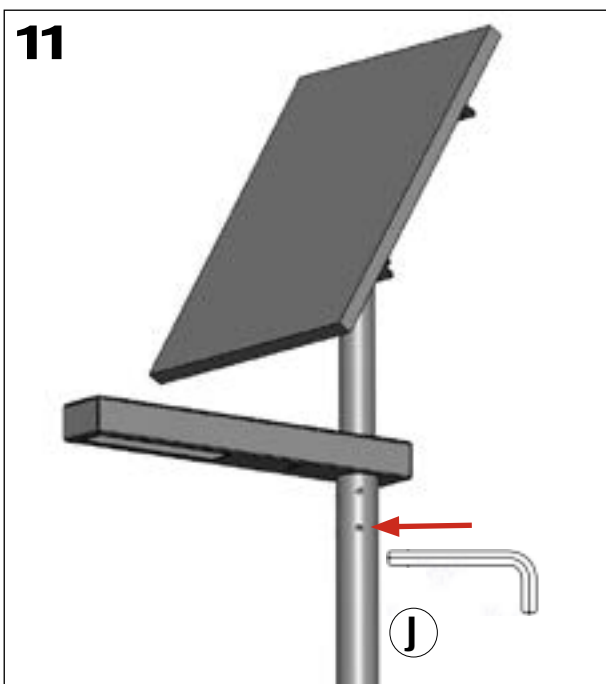
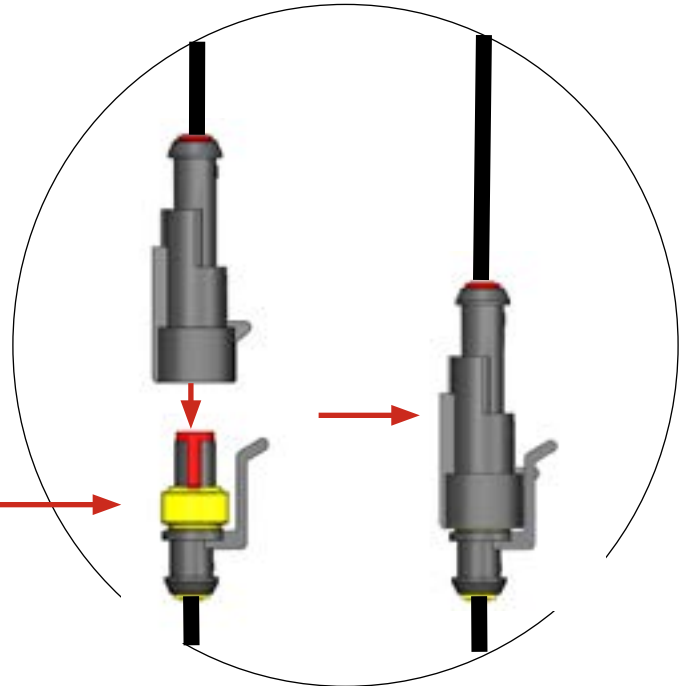
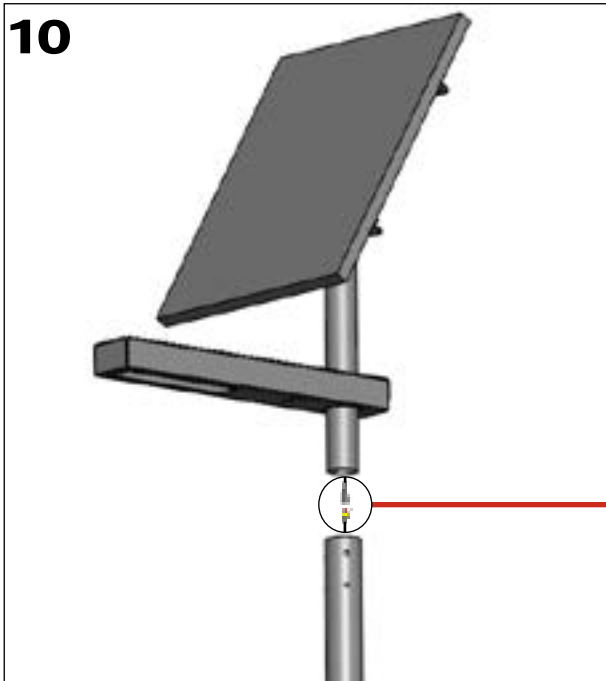

MONTAGEMÖGLICHKEIT 1 - ROHRFUNDAMENT

MOUNTING POSSIBILITY 1 - PIPE FOUNDATION

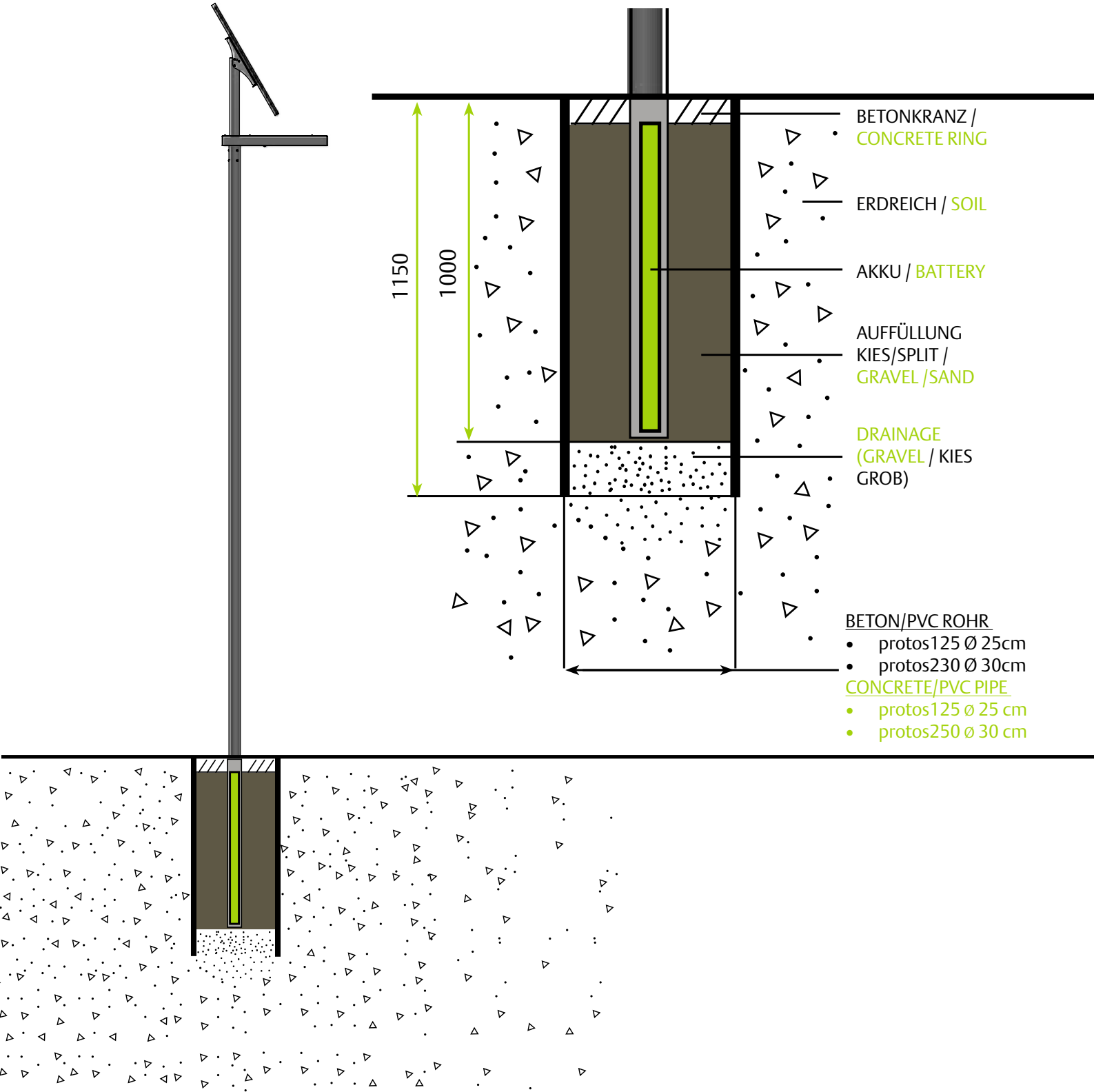

MONTAGEMÖGLICHKEIT 2 - SCHRAUBFUNDAMENT

MOUNTING POSSIBILITY 2 - GROUND SCREW FOUNDATION

KRINNER Screw Foundation

Art. 26160: KSF E140x1600-E76-100 for protos 125

Art. 25500: KSF E140x2100-E76-100 for protos 250 an protos duo

