



HORUS[®]
PHOTOVOLTAIC
PROTECTION



PHOTOVOLTAIC

FUSE LINKS & FUSE HOLDERS FOR PHOTOVOLTAIC APPLICATIONS

fuse puller

for NH-ST fuse links

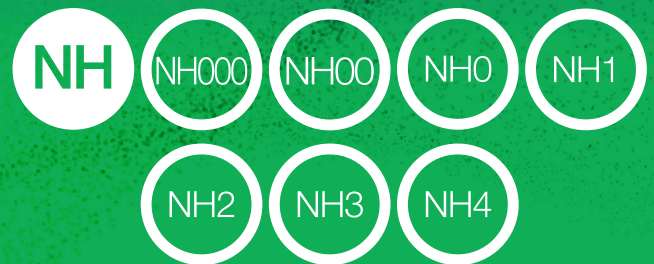

**PROTECTING
THE WORLD**



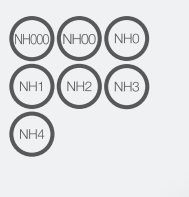

Universal fuse puller for NH fuse links size 000 up to NH4

According to IEC-EN 60269-2 may be used for live operations in systems up to 1000V AC/DC.

All materials are according to the European Directive RoHS (Restriction of the use of certain hazardous substances in electrical material).

According to CE



Warning of use

Installing or replacing of NH-fuse links is only allowed by instructed specialized staff.



It is forbidden to leave NH-fuse handle permanently plugged in inserted NH fuse links. Please use the handle only for installing or replacing.

If electric arcs can be occur or high voltages are to be switched, additional safety components such as protective screen or safety goggles are compulsory.

Before using the extraction handle and other safety components, make sure that they are in good condition.

Do not operate under load.

Range

REFERENCE	DESCRIPTION	PACKING
340001	UNIVERSAL FUSE PULLER FOR SIZES 000 UP TO 4	Uni /BOX 1



Dimensions

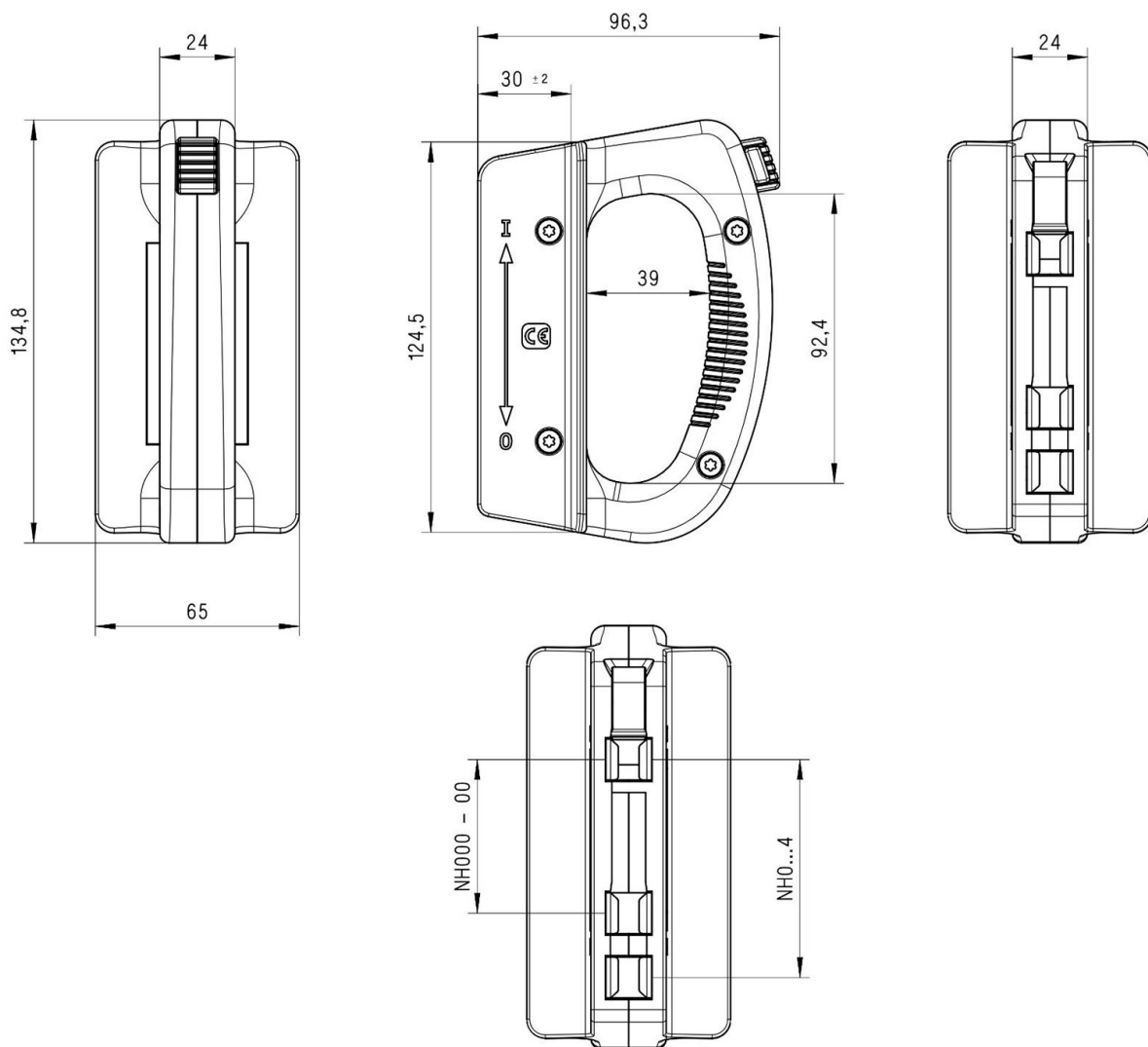

Weight 168gr



Instructions

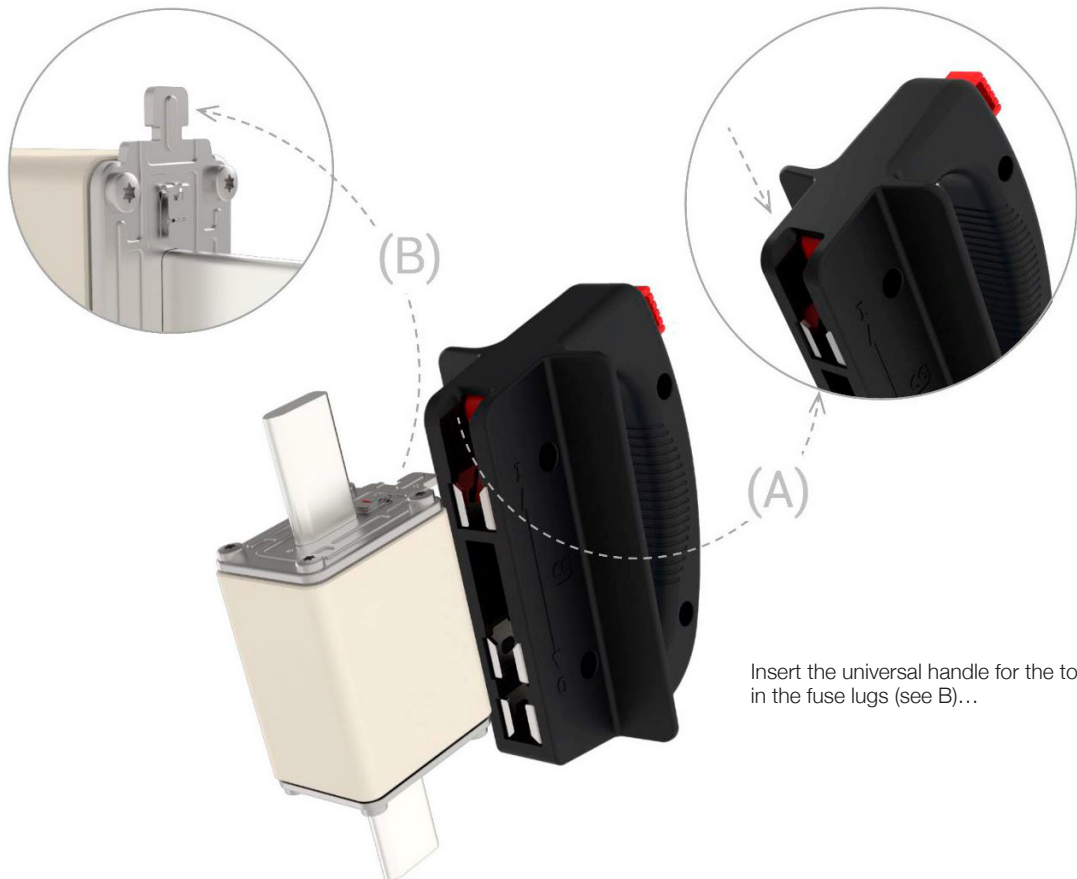

...move the universal handle upward until you hear a click!

Now the fuse is anchored and you can remove it or enter it in the fuseholder.

To remove the universal handle from the fuse, press the red button and move the handle downward.

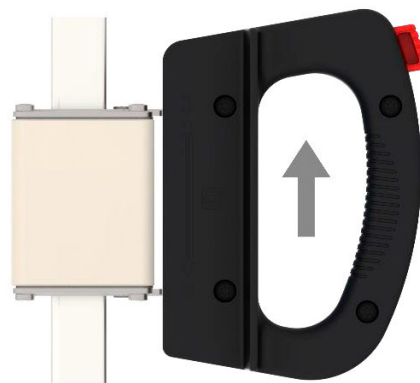

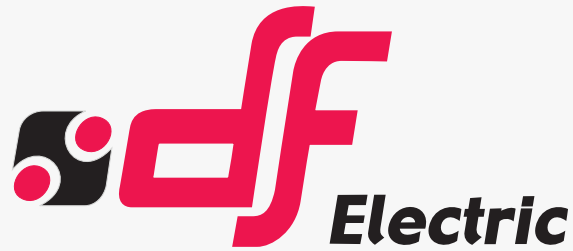

PROTECTING THE WORLD



HEAD OFFICE AND FACTORY
SILICI, 67-69
08940 CORNELLA DE LLOBREGAT
BARCELONA · SPAIN
Tel. +34 93 377 85 85
Fax +34 93 377 82 82

INTERNATIONAL SALES
Tel. +34 93 475 08 64
Fax +34 93 480 07 75
export@dfelectric.es

NATIONAL SALES
Tel. 93 475 08 64
Fax 93 480 07 76
comercial@dfelectric.es

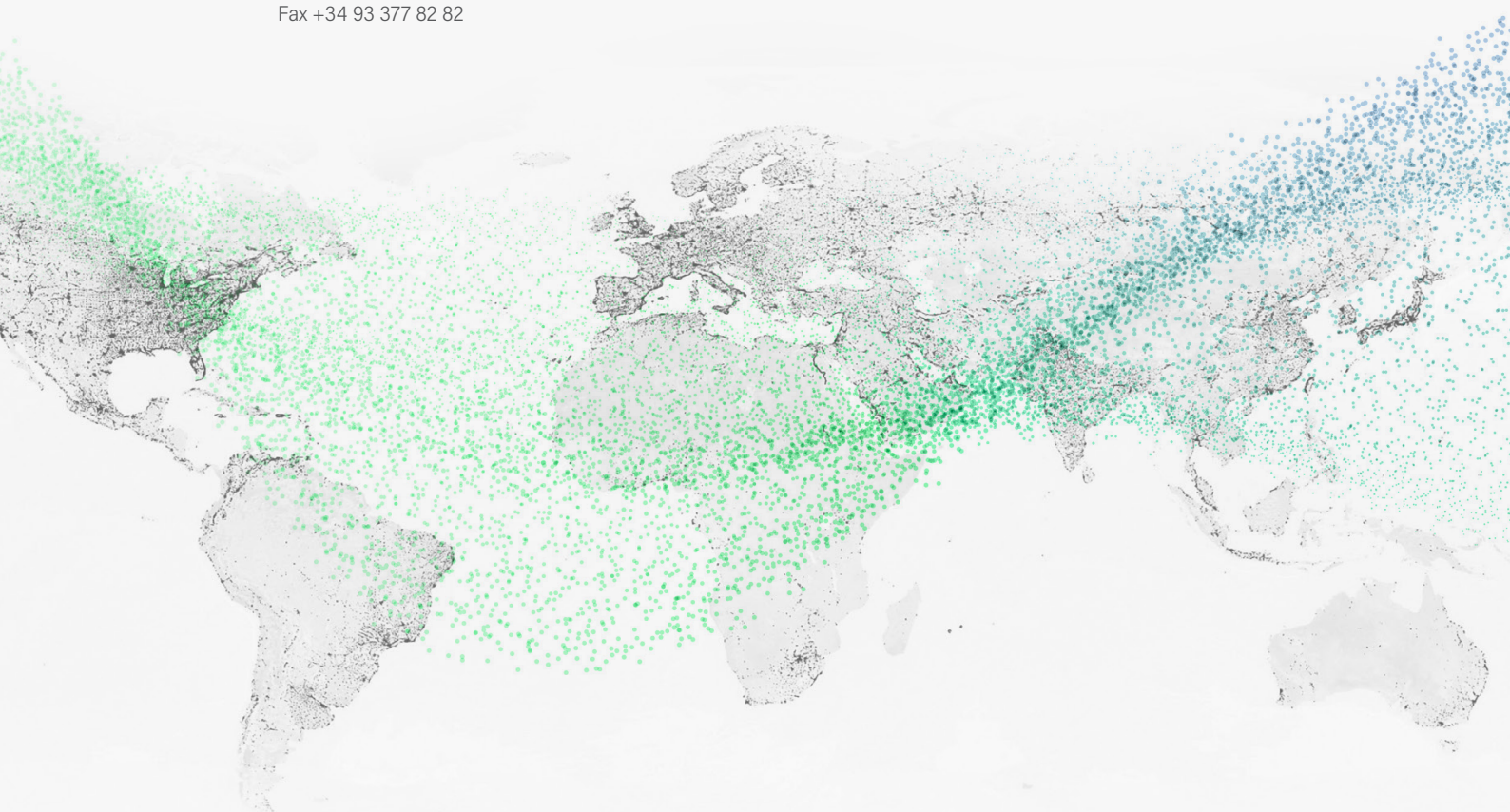

dfelectric.es



According to the waste of electrical and electronic equipment directive, electrical material should not be part of the usual waste. This symbol alerts users that these products should be recycled according to local environmental waste disposal regulations.



The "electro technical expert" logo marked on the products included in this data sheet indicates that the installation of these products must be carried out by expert personnel with specialized knowledge.



To prevent electrical hazards, carry out the installation without voltage.



Safety notice
Please capture the following QR code and read our safety notice carefully before installing our products.



The data reflected in this technical record are subject to the correct installation of the product in accordance with manufacturer's instructions, relevant installation standards and professional practices, maintained and used in applications for which they were made.

The products described in this document have been designed, developed and tested in accordance with specific standard. They are considered components that are integrated as part of installation, machine or equipment. The correct general operation of the referred product is responsibility of the manufacturer of the installation, machine or equipment.

DF ELECTRIC cannot guarantee the characteristics of an installation, machine or equipment that has been designed by a third party. Once a product has been selected, the user must verify that it is appropriate for its application, through the verifications and/or tests that it deems appropriate.

DF ELECTRIC retains the right to change the dimensions, specifications, materials or design of its products at any time with or without notice.

©2020 DF Electric. All rights reserved